

Article number: 20804025

Description: E+G Thrust pad
DIN 6311-25-S

Measures

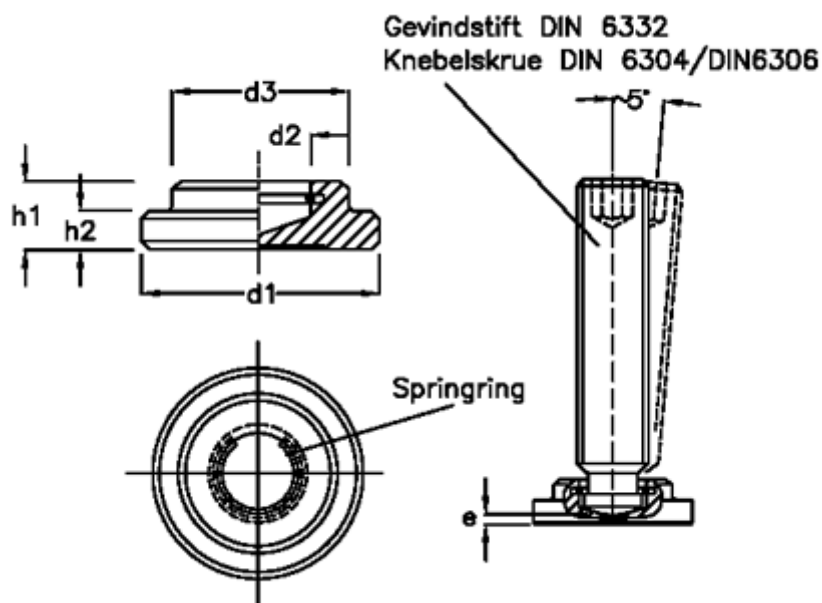

d1 = 25
d2 = 8.1
d3 = 18
e = 4.5
h1 = 13
h2 = 6.0
T = M12